

## DS-2CD2523G0-I(W)(S) 2 MP IR Fixed Mini Dome Network Camera



- High quality imaging with 2 MP resolution
- Efficient H.265+ compression technology
- Clear imaging against strong back light due to 120 dB true WDR technology
- Water and dust resistant (IP66) and vandal proof (IK08)
- -W: Wi-Fi connection
- -S: built-in microphone, audio and alarm interface available
- Mini size suitable for limited space



## ▪ Specification

Camera	
Image Sensor	1/2.7" Progressive Scan CMOS
Min. Illumination	Color: 0.028 lux @(F2.0, AGC ON), 0 lux with IR on
Shutter Speed	1/3 s to 1/100,000 s
Slow Shutter	Yes
Wide Dynamic Range	120 dB
Day & Night	IR Cut Filter
Angle Adjustment	Pan: -30° to 30°, tilt: 0° to 75°, rotate: 0° to 360°
Lens	
Lens Type	2.8, 4, 6 mm
FOV	2.8 mm, horizontal FOV: 114°, vertical FOV: 62°, diagonal FOV: 135° 4 mm, horizontal FOV: 86°, vertical FOV: 46°, diagonal FOV: 102° 6 mm, horizontal FOV: 54°, vertical FOV: 30°, diagonal FOV: 62°
Aperture	F2.0
Lens Mount	M12
Illuminator	
IR Range	Up to 10 m
Wavelength	850 nm
Video	
Max. Resolution	1920 × 1080
Main Stream	50Hz: 25 fps (1920 × 1080, 1280 × 960, 1280 × 720) 60Hz: 30 fps (1920 × 1080, 1280 × 960, 1280 × 720)
Sub-Stream	50Hz: 25 fps (640 × 480, 640 × 360, 320 × 240) 60Hz: 30 fps (640 × 480, 640 × 360, 320 × 240)
Third Stream	50Hz: 25 fps (1920 × 1080, 1280 × 720, 640 × 360, 352 × 288) 60Hz: 30 fps (1920 × 1080, 1280 × 720, 640 × 360, 352 × 240)
Video Compression	Main stream: H.265/H.264 Sub-stream: H.265/H.264 /MJPEG Third stream: H.265/H.264
Video Bit Rate	32 Kbps to 16 Mbps
H.264 Type	Main Profile/High Profile
H.265 Type	Main Profile
H.264+	Main stream supports
H.265+	Main stream supports
Scalable Video Coding (SVC)	Support H.264 and H.265 encoding
Audio	
Environment Noise Filtering	Yes
Audio Sampling Rate	8 kHz/16 kHz/32 kHz/44.1 kHz/48 kHz
Audio Compression	G722.1/G711ulaw/G711alaw/G726/MP2L2/PCM
Audio Bit Rate	64Kbps(G.711)/16Kbps(G.722.1)/16Kbps(G.726)/32-192Kbps(MP2L2)
Network	
Simultaneous Live View	Up to 6 channels
API	ONVIF (PROFILE S, PROFILE G, PROFILE T), ISAPI, SDK, Ehome

Protocols	TCP/IP, UDP, ICMP, HTTP, HTTPS, FTP, DHCP, DNS, DDNS, RTP, RTSP, RTCP, PPPoE, NTP, UPnP, SMTP, SNMP, IGMP, 802.1X, QoS, IPv6, Bonjour, SSL/TLS
User/Host	Up to 32 users. 3 levels: administrator, operator and user
Security	Password protection, complicated password, HTTPS encryption, 802.1X authentication (EAP-TLS 1.2, EAP-LEAP, EAP-MD5), watermark, IP address filter, basic and digest authentication for HTTP/HTTPS, WSSE and digest authentication for ONVIF, TLS1.2
Network Storage	Support Micro SD/SDHC/SDXC card (128 GB), local storage and NAS (NFS, SMB/CIFS), ANR
Client	Wired network: Hik-Connect, iVMS-4200, Hik-Central Wi-Fi: iVMS-4200, Hik-Central *Wi-Fi connection with Hik-Connect directly is not possible.
Web Browser	Plug-in required live view: IE 8+ Plug-in free live view: Chrome 57.0+, Firefox 52.0+, Safari 11+ Local Service: Chrome 41.0+, Firefox 30.0+
Alarm Trigger	Motion detection, video tampering, network disconnected, IP address conflict, HDD full, HDD error, illegal login
<b>Wi-Fi</b>	
Encryption Mode	-W: WPA, WPA2
Wi-Fi Protocol	-W: IEEE 802.11b/g/n
Frequency Range	-W: 2.412 GHz to 2.4835 GHz
Channel Bandwidth	-W: 20 M/40 M
Wireless Range	-W: Up to 50 m (The performance varies based on actual environment)
Transfer Rate	-W: 11b: 11 Mbps 11g: 54 Mbps 11n: up to 150 Mbps
<b>Image</b>	
Day/Night Switch	Auto/Schedule/Day/Night/Triggered by Alarm In (-S)
Image Enhancement	BLC/3D DNR/HLC
Image Settings	Rotate mode, saturation, brightness, contrast, sharpness and white balance adjustable by client software or web browser
<b>Interface</b>	
Audio	-S: 2 inputs: line in, or mic in (built-in microphone) 1 output: line out, mono sound, terminal block
Alarm	-S: 1 input: alarm in; 1 output: alarm out (max. 12 VDC, 30 mA), terminal block
On-board Storage	Built-in MicroSD/SDHC/SDXC slot, up to 128 GB
Hardware Reset	Yes
Communication Interface	1 RJ45 10M/100M self-adaptive Ethernet port
<b>Event</b>	
Basic Event	Motion detection, video tampering alarm, exception (network disconnected, IP address conflict, illegal login, HDD full, HDD error)
Smart Event	Line crossing detection, intrusion detection, face detection
Face Detection	Yes

General	
Linkage Method	Trigger recording: memory card, network storage, pre-record and post-record Trigger captured pictures uploading: FTP, HTTP, NAS, Email Trigger notification: HTTP, ISAPI, alarm output , Email
Firmware Version	V5.6.5
Web Client Language	32 languages English, Russian, Estonian, Bulgarian, Hungarian, Greek, German, Italian, Czech, Slovak, French, Polish, Dutch, Portuguese, Spanish, Romanian, Danish, Swedish, Norwegian, Finnish, Croatian, Slovenian, Serbian, Turkish, Korean, Traditional Chinese, Thai, Vietnamese, Japanese, Latvian, Lithuanian, Portuguese (Brazil)
General Function	Anti-flicker, three streams, heartbeat, mirror, privacy masks, password reset via e-mail, pixel counter, HTTP listening
Startup and Operating Conditions	-30 °C to +60 °C (-22 °F to +140 °F), humidity 95% or less (non-condensing)
Power Supply	12 VDC ± 25% PoE (802.3af, class 3)
Power Consumption and Current	12 VDC, 0.7 A, max. 8.5 W, Ø5.5mm coaxial plug power PoE (802.3af, 36 V to 57 V), 0.3 A to 0.1 A, max. 10 W
Camera Dimension	Ø120 mm × 67.4 mm (Ø4.7" × 2.7")
Camera Weight	Camera: approx. 400 g (0.9 lb.)
Approval	
Protection	Ingress protection: IP66 (IEC 60529-2013), IK08 (IEC 60529-2013)

## ▪ Available Model

DS-2CD2523G0-I (2.8/4/6 mm)

DS-2CD2523G0-IS (2.8/4/6 mm)

DS-2CD2523G0-IW (2.8/4/6 mm)

DS-2CD2523G0-IWS (2.8/4/6 mm)



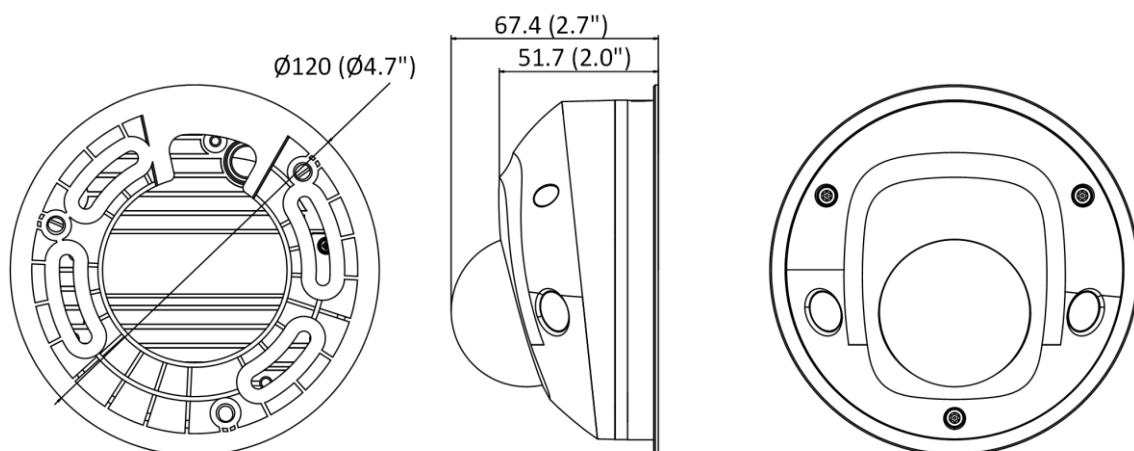



## ▪ Dimension



Unit: mm (inch)

▪ **Accessory**

▪ **Optional**

DS-1275ZJ-SUS Vertical pole mount	DS-1272ZJ-120 Wall mount	DS-1276ZJ-SUS Corner mount	DS-1280ZJ-DM46 Junction box	DS-1271ZJ-120 Pendant Mount
				
<b>DS-1272ZJ-120B</b>				
<b>Wall mount</b>				
				

Distributed by



## HIKVISION®

**Headquarters**

No.555 Qianmo Road, Binjiang District,  
Hangzhou 310051, China  
T +86-571-8807-5998  
overseasbusiness@hikvision.com

**Hikvision USA**  
T +1-909-895-0400  
sales.usa@hikvision.com

**Hikvision Australia**  
T +61-2-8599-4233  
salesau@hikvision.com

**Hikvision India**  
T +91-22-28469900  
sales@pramahikvision.com

**Hikvision Canada**  
T +1-866-200-6690  
sales.canada@hikvision.com

**Hikvision Thailand**  
T +662-275-9949  
sales.thailand@hikvision.com

**Hikvision Europe**  
T +31-23-5542770  
sales.eu@hikvision.com

**Hikvision Italy**  
T +39-0438-6902  
info.it@hikvision.com

**Hikvision Brazil**  
T +55 11 3318-0050  
Latam.support@hikvision.com

**Hikvision Turkey**  
T +90 [216]521 7070- 7074  
sales.tr@hikvision.com

**Hikvision Malaysia**  
T +601-7652-2413  
sales.my@hikvision.com

**Hikvision UK & Ireland**  
T +01628-902140  
sales.uk@hikvision.com

**Hikvision South Africa**  
Tel: +27 (10) 0351172  
sale.africa@hikvision.com

**Hikvision France**  
T +33(0)1-85-330-450  
info.fr@hikvision.com

**Hikvision Kazakhstan**  
T +7-727-9730667  
nikia.panfilov@hikvision.ru

**Hikvision Vietnam**  
T +84-974270888  
sales.vt@hikvision.com

**Hikvision UAE**  
T +971-4-4432090  
salesme@hikvision.com

**Hikvision Singapore**  
T +65-6684-4718  
sg@hikvision.com

**Hikvision Spain**  
T +34-91-737-16-55  
info.es@hikvision.com

**Hikvision Tashkent**  
T +99-87-1238-9438  
uzb@hikvision.ru

**Hikvision Hong Kong**  
T +852-2151-1761  
info.hk@hikvision.com

**Hikvision Russia**  
T +7-495-669-67-99  
saleru@hikvision.com

**Hikvision Korea**  
T +82-(0)31-731-8817  
sales.korea@hikvision.com

**Hikvision Poland**  
T +48-22-460-01-50  
info.pl@hikvision.com

**Hikvision Indonesia**  
T +62-21-2933759  
Sales.Indonesia@hikvision.com

**Hikvision Colombia**  
sales.colombia@hikvision.com